

-20°C ÷ +120°C
Subject to applications



Working pressure:
14 Bar (at 20°C)
Depending on the tube used



Compressed air, water and fluids suitable with construction materials



Taper gas BSPT ISO 7
from R1/8" to R1"



Plastic, silicone, PTFE, FEP and soft PVC tubes



Body: Polyvinylidene fluoride (PVDF)

AVAILABILITY

Available on demand with NPT thread for inch tubes.



Food contact materials
EC 1935/2004



D.M. 174/2004



NSF 61 / NSF 372
NSF certificate on behalf of Tefen Flow and Dosing Technologies Ltd.



Products in compliance with
EC Regulation 1907/2006



Products in compliance with
the directive EU 2015/863

FEATURES

- The fittings of this series have plastic thread and consequently we recommend to avoid excessive force during screwing and to use teflon on the thread before use in order to prevent any type of loss.
- The connection to the tube must be secured with a 5090 clamp.

DIAMETER OF THE BARB

BARB CONNECTORS - PVDF

ØD (mm)	Ø4	Ø5	Ø6	Ø8	Ø10	Ø12	Ø14	Ø16	Ø19	Ø25
ØB (mm)	5,2	6,3	8,0	10,0	12,0	14,0	16,2	18,2	21,0	26,0

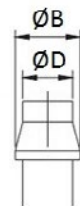

TIGHTENING TORQUE

TAPER GAS BSPT ISO 7

THREAD	1/8"	1/4"	3/8"	1/2"	3/4"	1"
Nm	0,1	1	5	8	16	26

CONSTRUCTION DETAILS

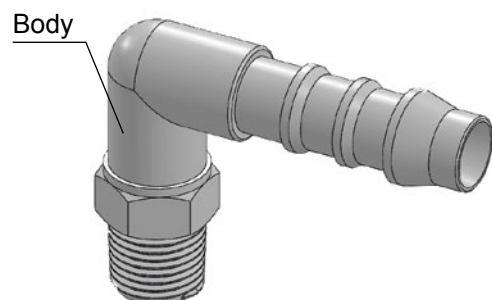

5905

Female barb connector BSPT thread

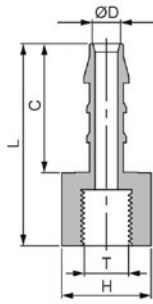

CODE	T	ØD	C	L	H	g
5905TR185	R 1/8"	5	21,0	34,4	14	2,0
5905TR145	R 1/4"	5	21,0	35,0	17	2,7
5905TR385	R 3/8"	5	21,0	36,5	22	4,57
5905TR125	R 1/2"	5	21,5	38,7	26	6,6
5905TR186	R 1/8"	6	23,0	36,3	14	2,15
5905TR146	R 1/4"	6	23,0	37,2	17	2,9
5905TR386	R 3/8"	6	23,0	38,3	22	4,8
5905TR126	R 1/2"	6	23,0	40,8	26	7,0
5905TR188	R 1/8"	8	25,0	38,2	14	2,5
5905TR148	R 1/4"	8	25,0	39,4	17	5,0
5905TR388	R 3/8"	8	25,0	40,4	22	7,1
5905TR128	R 1/2"	8	25,0	42,7	26	3,6
5905TR1410	R 1/4"	10	27,5	41,5	17	5,4
5905TR3810	R 3/8"	10	27,0	42,3	22	7,5
5905TR1210	R 1/2"	10	27,5	45,0	26	4,1
5905TR1412	R 1/4"	12	28,0	42,4	17	6,2
5905TR3812	R 3/8"	12	28,0	43,3	22	8,0
5905TR1212	R 1/2"	12	28,0	46,0	26	6,9
5905TR3814	R 3/8"	14	30,0	45,0	22	8,7
5905TR1214	R 1/2"	14	30,0	47,3	26	9,0
5905TR1216	R 1/2"	16	30,5	48,1	26	9,5
5905TR1219	R 1/2"	19	31,0	48,8	26	10,0



5910

Male barb conector BSPT thread

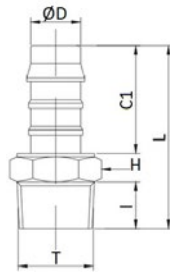

CODE	T	ØD	I	C1	L	H	g
5910TR184	R 1/8"	4	8,0	16,0	31,2	11	1,0
5910TR144	R 1/4"	4	10,0	16,0	33,8	14	1,2
5910TR185	R 1/8"	5	8,0	21,0	34,7	11	1,0
5910TR145	R 1/4"	5	10,0	21,0	38,3	14	1,0
5910TR186	R 1/8"	6	8,0	23,0	37,5	11	1,0
5910TR146	R 1/4"	6	10,0	23,0	39,2	14	2,0
5910TR386	R 3/8"	6	10,0	23,0	39,1	17	3,0
5910TR126	R 1/2"	6	12,5	23,0	42,3	22	6,0
5910TR346	R 3/4"	6	14,5	23,0	43,0	22	8,2
5910TR188	R 1/8"	8	8,0	25,0	39,8	11	2,0
5910TR148	R 1/4"	8	10,0	25,0	43,0	14	2,0
5910TR388	R 3/8"	8	10,0	25,0	43,0	17	3,0
5910TR128	R 1/2"	8	12,5	25,0	46,1	22	6,0
5910TR348	R 3/4"	8	12,5	25,0	37,1	17	4,7
5910TR1410	R 1/4"	10	10,0	27,0	47,1	14	1,0
5910TR3810	R 3/8"	10	10,0	27,0	45,2	17	4,0
5910TR1210	R 1/2"	10	12,5	27,0	48,3	22	6,0
5910TR3410	R 3/4"	10	14,5	27,0	49,3	27	9,1
5910TR1412	R 1/4"	12	10,0	28,0	46,0	14	4,0
5910TR3812	R 3/8"	12	10,0	28,0	46,0	17	4,0
5910TR1212	R 1/2"	12	12,5	28,0	49,3	22	7,0
5910TR3412	R 3/4"	12	14,5	28,0	50,0	27	9,2
5910TR3814	R 3/8"	14	10,0	29,5	47,5	17	6,0
5910TR1214	R 1/2"	14	12,5	29,5	50,8	22	7,0
5910TR3414	R 3/4"	14	14,5	29,5	51,7	27	9,8
5910TR1216	R 1/2"	16	12,5	30,0	51,3	22	8,0
5910TR3416	R 3/4"	16	14,5	30,0	52,2	27	10,0
5910TR1219	R 1/2"	19	12,5	31,0	52,2	22	9,0
5910TR3419	R 3/4"	19	14,5	31,0	53,3	27	15,0
5910TR119	R 1"	19	21,0	31,0	60,1	27	18,8
5910TR3425	R 3/4"	25	21,0	31,0	54,8	27	17,0
5910TR125	R 1"	25	21,0	31,0	66,6	36	19,5



5920

Male elbow barb connector BSPT thread

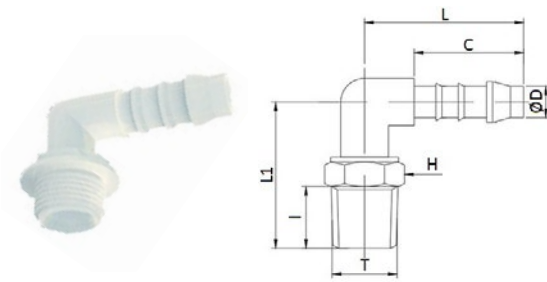

CODE	T	ØD	I	C	L	L1	H	g
5920TR184	R 1/8"	4	8,0	16,0	22,5	21,0	11	1,0
5920TR144	R 1/4"	4	10,0	16,0	22,5	24,0	14	1,0
5920TR185	R 1/8"	5	8,0	21,0	28,0	24,0	11	1,0
5920TR145	R 1/4"	5	10,0	21,0	28,0	26,0	14	3,0
5920TR125	R 1/2"	5	13,0	21,0	28,0	30,0	22	6,0
5920TR186	R 1/8"	6	8,5	23,5	31,5	23,5	11	1,0
5920TR146	R 1/4"	6	10,0	23,0	31,0	26,0	14	3,0
5920TR386	R 3/8"	6	10,5	23,0	31,0	26,0	17	3,0
5920TR126	R 1/2"	6	13,0	23,5	31,5	30,0	22	7,0
5920TR188	R 1/8"	8	8,0	25,0	36,0	26,0	11	3,0
5920TR148	R 1/4"	8	10,0	25,0	36,0	28,0	14	3,0
5920TR388	R 3/8"	8	10,5	25,0	36,0	28,0	17	5,0
5920TR128	R 1/2"	8	13,0	25,0	36,0	30,5	22	7,0
5920TR1410	R 1/4"	10	10,0	27,0	39,0	28,0	14	4,0
5920TR3810	R 3/8"	10	10,5	27,0	39,0	28,0	17	6,0
5920TR1210	R 1/2"	10	13,0	27,0	39,0	30,5	22	8,0
5920TR3410	R 3/4"	10	14,5	27,0	39,0	33,5	27	9,9
5920TR1412	R 1/4"	12	10,0	28,0	41,0	28,0	14	7,0
5920TR3812	R 3/8"	12	10,5	28,0	41,0	28,0	17	8,0
5920TR1212	R 1/2"	12	13,0	28,0	41,0	32,0	22	9,0
5920TR3412	R 3/4"	12	14,5	28,0	41,0	34,0	27	12,0
5920TR3814	R 3/8"	14	10,5	29,5	42,5	31,5	17	9,0
5920TR1214	R 1/2"	14	13,0	29,5	42,5	34,0	22	11,0
5920TR3414	R 3/4"	14	14,5	29,5	42,5	37,5	27	14,4
5920TR1216	R 1/2"	16	12,5	30,0	44,0	36,0	22	13,0
5920TR3416	R 3/4"	16	14,5	30,0	44,0	39,0	27	14,0
5920TR1219	R 1/2"	19	12,5	31,0	45,0	36,0	22	15,0
5920TR3419	R 3/4"	19	15,0	31,0	45,0	38,0	27	16,6



5925

Male tee barb connector BSPT thread

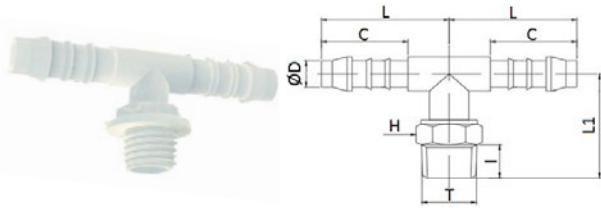

CODE	T	ØD	I	C	L	L1	H	g
5925TR184	R 1/8"	4	8,0	16,0	19,7	18,5	11	1,0
5925TR144	R 1/4"	4	10,5	16,0	22,6	21,5	14	2,5
5925TR185	R 1/8"	5	8,0	21,0	25,4	19,5	11	1,0
5925TR145	R 1/4"	5	10,5	21,0	28,2	22,5	14	3,0
5925TR186	R 1/8"	6	8,5	23,5	28,0	23,5	11	1,0
5925TR146	R 1/4"	6	10,5	23,0	31,5	23,0	14	3,0
5925TR386	R 3/8"	6	13,0	23,0	31,5	23,0	17	4,1
5925TR126	R 1/2"	6	12,5	23,0	31,5	27,0	22	7,1
5925TR188	R 1/8"	8	8,0	25,0	30,8	21,5	11	3,0
5925TR148	R 1/4"	8	10,5	25,0	36,3	24,5	14	5,0
5925TR388	R 3/8"	8	10,5	25,0	36,3	24,5	17	6,0
5925TR128	R 1/2"	8	13,0	25,0	31,0	28,5	22	7,5
5925TR1410	R 1/4"	10	10,0	27,0	39,3	28,0	14	6,4
5925TR3810	R 3/8"	10	10,5	27,0	39,3	28,0	17	7,3
5925TR1210	R 1/2"	10	12,5	27,0	39,4	30,5	22	9,6
5925TR3410	R 3/4"	10	13,0	27,0	39,4	31,5	27	11,8
5925TR1412	R 1/4"	12	10,0	28,0	41,3	28,0	14	15,0
5925TR3812	R 3/8"	12	10,5	28,0	41,3	28,0	17	9,0
5925TR1212	R 1/2"	12	13,0	28,0	41,3	31,5	22	12,6
5925TR3412	R 3/4"	12	13,0	28,0	41,3	31,5	27	14,3
5925TR3814	R 3/8"	14	10,5	29,5	42,8	31,5	17	12,8
5925TR1214	R 1/2"	14	12,5	29,5	42,8	34,0	22	15,0
5925TR3414	R 3/4"	14	13,0	30,0	42,8	35,0	27	17,9
5925TR1216	R 1/2"	16	12,5	30,0	44,1	36,0	22	15,0
5925TR3416	R 3/4"	16	13,5	30,0	44,2	37,0	27	18,6
5925TR1219	R 1/2"	19	12,5	31,0	45,1	36,0	22	19,6
5925TR3419	R 3/4"	19	13,5	31,0	45,3	36,0	27	21,6

5930

Union elbow barb connector

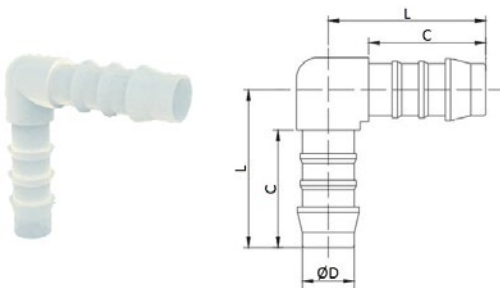

CODE	ØD	C	L	g
5930TR4	4	16,0	23,0	1,0
5930TR5	5	21,0	28,5	1,2
5930TR6	6	23,0	31,5	1,5
5930TR8	8	25,0	36,5	3,0
5930TR10	10	27,0	39,0	4,0
5930TR12	12	28,0	40,0	7,0
5930TR14	14	29,5	42,5	9,0
5930TR16	16	30,0	44,0	11,0
5930TR19	19	31,0	45,0	13,0



5935

Reduced union elbow barb connector

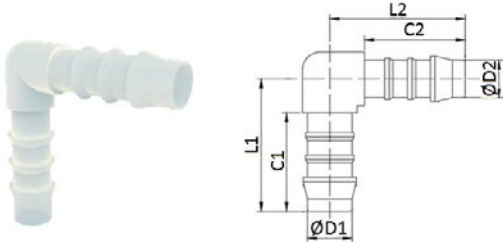

CODE	ØD1	ØD2	C1	C2	L1	L2	g
5935TR54	5	4	21,0	16,0	28,5	23,0	1,0
5935TR64	6	4	21,0	16,0	35,5	29,0	1,0
5935TR65	6	5	23,0	21,0	31,5	28,5	1,5
5935TR86	8	6	25,0	23,0	36,5	31,5	2,0
5935TR106	10	6	27,0	23,0	39,0	31,5	3,8
5935TR108	10	8	27,0	25,0	39,0	36,5	4,0
5935TR1210	12	10	28,0	27,0	40,0	39,0	7,0
5935TR1412	14	12	29,5	28,0	42,5	40,0	9,0
5935TR1614	16	14	30,0	29,5	44,0	42,5	11,0
5935TR1916	19	16	31,0	30,0	45,0	44,0	14,0

5940

Union barb connector

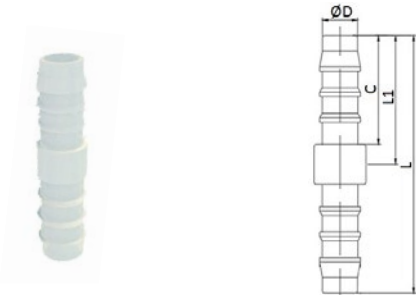

CODE	ØD	C	L	L1	g
5940TR4	4	16,0	36,6	18,0	1,0
5940TR5	5	21,0	47,0	23,5	1,2
5940TR6	6	23,0	52,2	26,0	1,5
5940TR8	8	25,0	59,3	29,0	2,0
5940TR10	10	27,0	63,0	31,5	3,0
5940TR12	12	28,0	66,0	33,0	4,0
5940TR14	14	29,5	71,8	35,5	7,5
5940TR16	16	30,0	72,5	36,0	9,0
5940TR19	19	31,0	73,5	37,0	11,0

5945

Reduced union barb connector

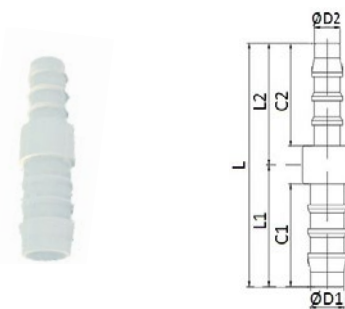

CODE	ØD1	ØD2	C1	L1	C2	L2	L	g
5945TR54	5	4	21,0	23,5	16,0	18,0	42,2	1,0
5945TR64	6	4	23,0	26,0	16,0	18,0	45,7	1,0
5945TR65	6	5	23,0	26,0	21,0	23,5	50,6	1,0
5945TR85	8	5	25,0	29,5	21,0	23,5	54,4	2,0
5945TR86	8	6	25,0	29,0	23,0	26,0	56,3	3,0
5945TR106	10	6	27,0	31,5	23,0	26,0	59,0	3,0
5945TR108	10	8	27,0	31,5	25,0	29,0	62,0	3,0
5945TR128	12	8	28,0	33,0	25,0	29,0	63,8	3,0
5945TR1210	12	10	28,0	33,0	27,0	31,5	65,3	5,0
5945TR1410	14	10	29,5	35,5	27,0	31,5	69,1	6,0
5945TR1412	14	12	29,5	35,5	28,0	33,0	70,0	7,0
5945TR1612	16	12	30,0	36,0	28,0	33,0	70,3	7,0
5945TR1614	16	14	30,0	36,0	29,5	35,5	71,7	8,0
5945TR1914	19	14	31,0	37,0	29,5	35,5	72,7	10,0
5945TR1916	19	16	31,0	37,0	30,0	36,0	73,2	10,0



5950

Union tee barb connector

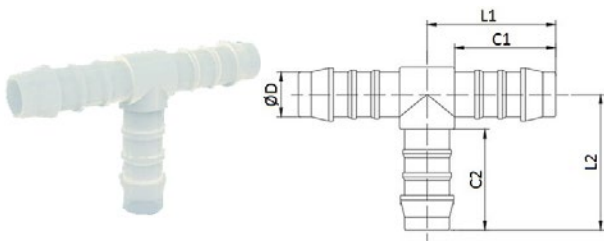

CODE	ØD	C1	L1	C2	L2	g
5950TR4	4	16,0	19,7	16,0	20,5	1,0
5950TR5	5	21,0	25,3	21,0	26,5	1,0
5950TR6	6	23,0	28,0	23,0	29,0	1,0
5950TR8	8	25,0	30,8	25,0	32,5	3,0
5950TR10	10	27,0	33,2	27,0	33,5	5,0
5950TR12	12	28,0	35,2	28,0	37,5	8,0
5950TR14	14	29,5	38,1	29,5	42,5	12,0
5950TR16	16	30,0	39,6	30,0	44,0	13,0
5950TR19	19	31,0	42,2	31,0	45,0	17,0

5955

Reduced union tee barb connector

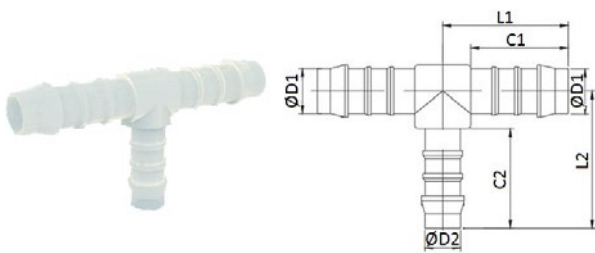

CODE	ØD1	ØD2	C1	L1	C2	L2	g
5955TR54	5	4	21,0	25,3	16,0	21,5	1,0
5955TR65	6	5	23,0	27,8	21,0	27,0	2,0
5955TR86	8	6	25,0	30,7	23,0	30,5	3,0
5955TR108	10	8	27,0	33,2	25,0	34,0	4,0
5955TR1210	12	10	28,0	35,3	27,0	36,5	7,0
5955TR1412	14	12	29,5	38,3	28,0	38,5	11,0
5955TR1614	16	14	30,0	39,7	29,5	41,5	13,0
5955TR1916	19	16	31,0	42,3	30,0	43,0	17,0

5960

Union Y barb connector

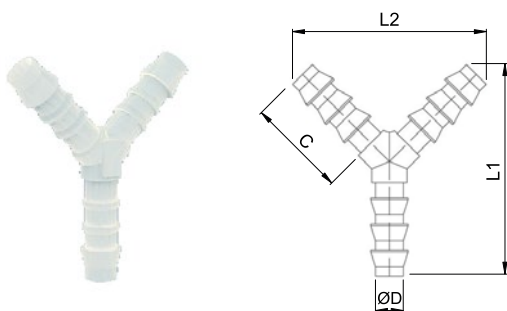

CODE	ØD	C	L1	L2	g
5960TR4	4	16,5	35,0	31,0	1,0
5960TR6	6	23,5	51,2	44,5	1,5
5960TR8	8	25,5	56,6	40,6	3,0
5960TR10	10	24,0	62,3	55,0	5,0
5960TR17	17	24,0	63,3	57,7	7,0

